

Dent ref : 101.6072LL-5
Poids : 8,4Kg

Support ref : 200-QCA-4710
Poids : 0,55Kg

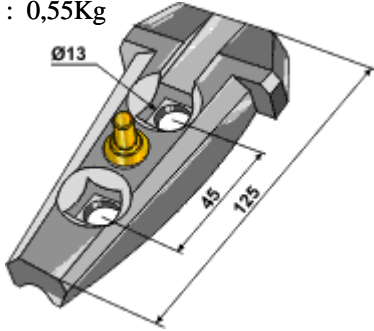

injecteurs ref : 300-HLD-4710
Poids : 1,9Kg

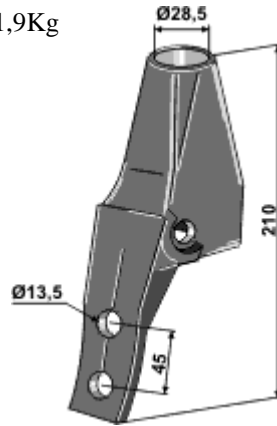

Soc largeur 250
ref : 200-PWV-1000
Poids : 1,7Kg

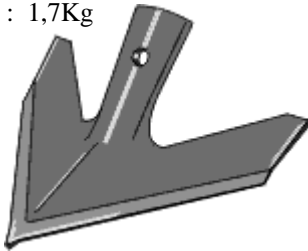

Injecteurs semence
ref : 300-ATM-1000
Poids : 0,95Kg

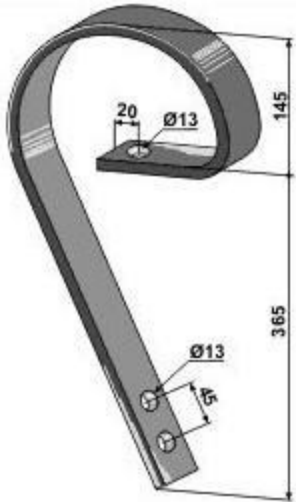
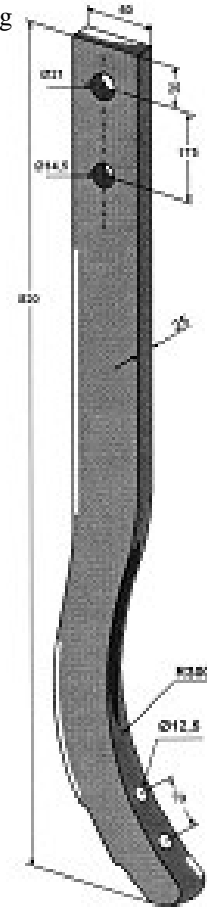
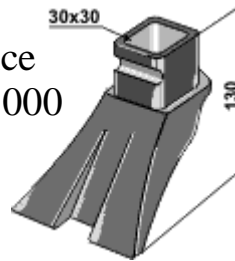

Dent traceur
ref : 10.1045

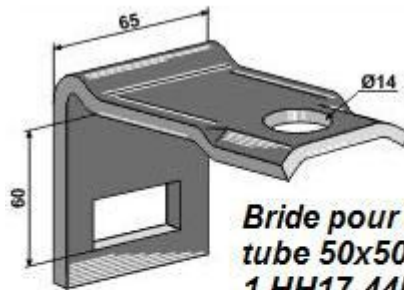

Bride pour traceur
tube 50x50 ref :
1.HH17-4451

Fixation avec un boulon
H M12x90

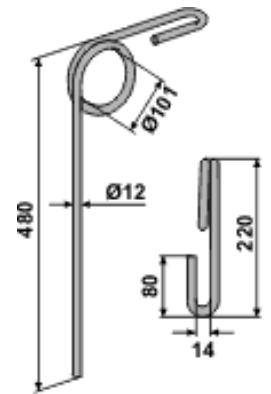

Peigne ref : 1000STE

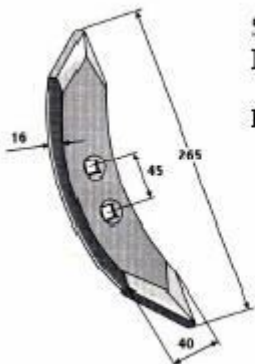

Soc largeur 40
Ref : SPRS

Poids : 0,8Kg

Fixation d'un soc :
2 boulons de charrue M11x60

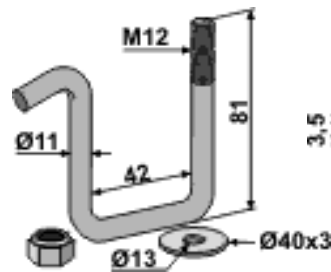

Bride Peigne ref : 10.ST-HH-12



Rondelle Peigne ref :
10.ST-HH-3