

## T drill

Dent C25  
Droite ref : 101.3045  
Gauche ref : 101.304  
Poids : 9,1Kg

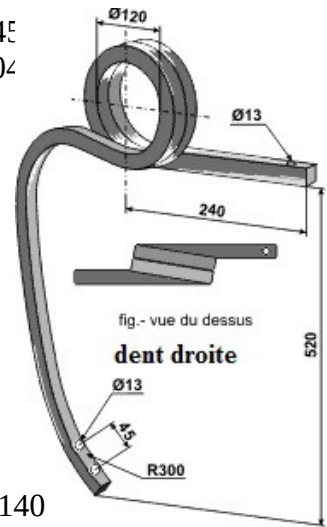

Dent C30  
Droite ref : 101.304581  
Gauche ref : 101.304591  
Poids : 12,5Kg

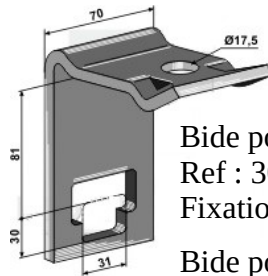
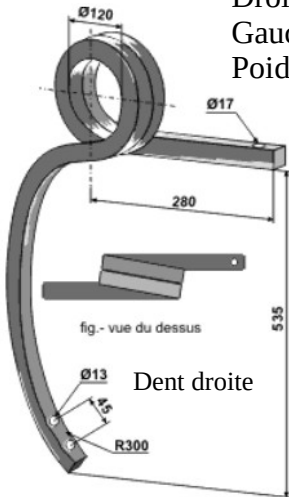

Bide pour Dent C30  
Ref : 30-101-5663  
Fixation avec un boulon M16x140

Bide pour Dent C25  
Ref : 30-101-5653  
Fixation avec un boulon M16x140  
Poids : 0,9Kg

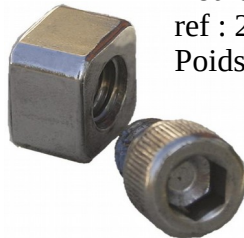
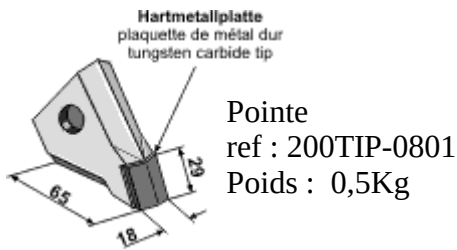

**Pointe**  
ref : 200TIP-3000  
Poids : 1,1Kg

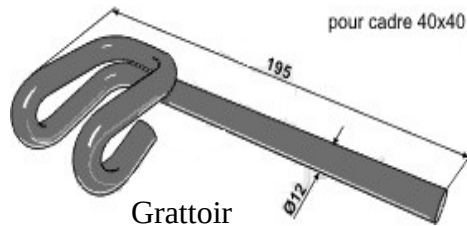
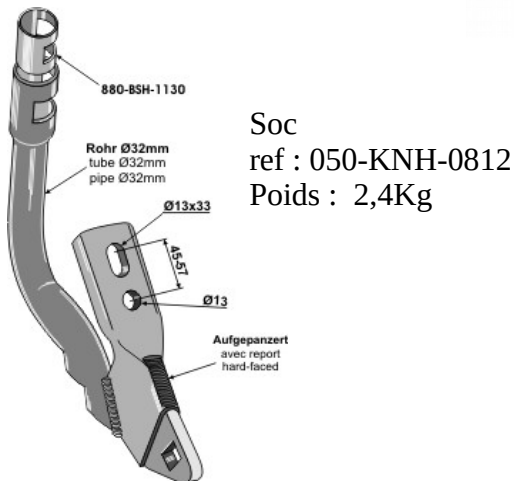
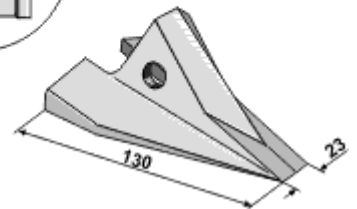

**Grattoir**  
ref : 316-ST-TI  
Poids : 0,4Kg

Pour le Grattoir

**Boulon**  
ref : 10806038V

**Rondelle**  
Ref : 10.ST-HH-24

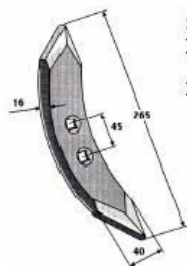
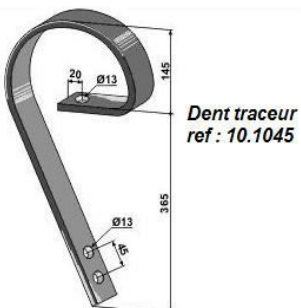

Fixation d'un soc :  
2 boulons de charrie M11x60

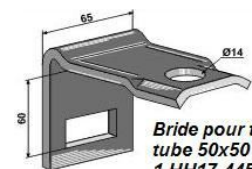

Fixation avec un boulon  
H M12x90